

INTÉRIEURS EN KIT

MONA THOMAS

MONA THOMAS

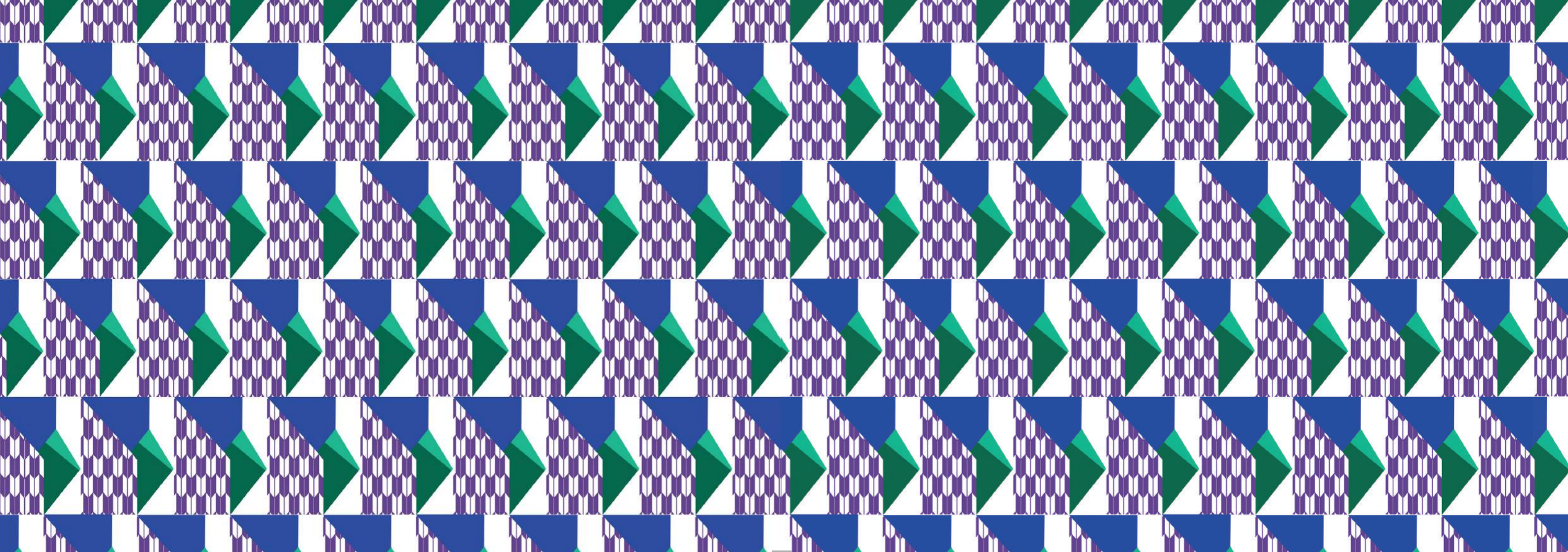

MONA THOMAS

Intérieurs en kit

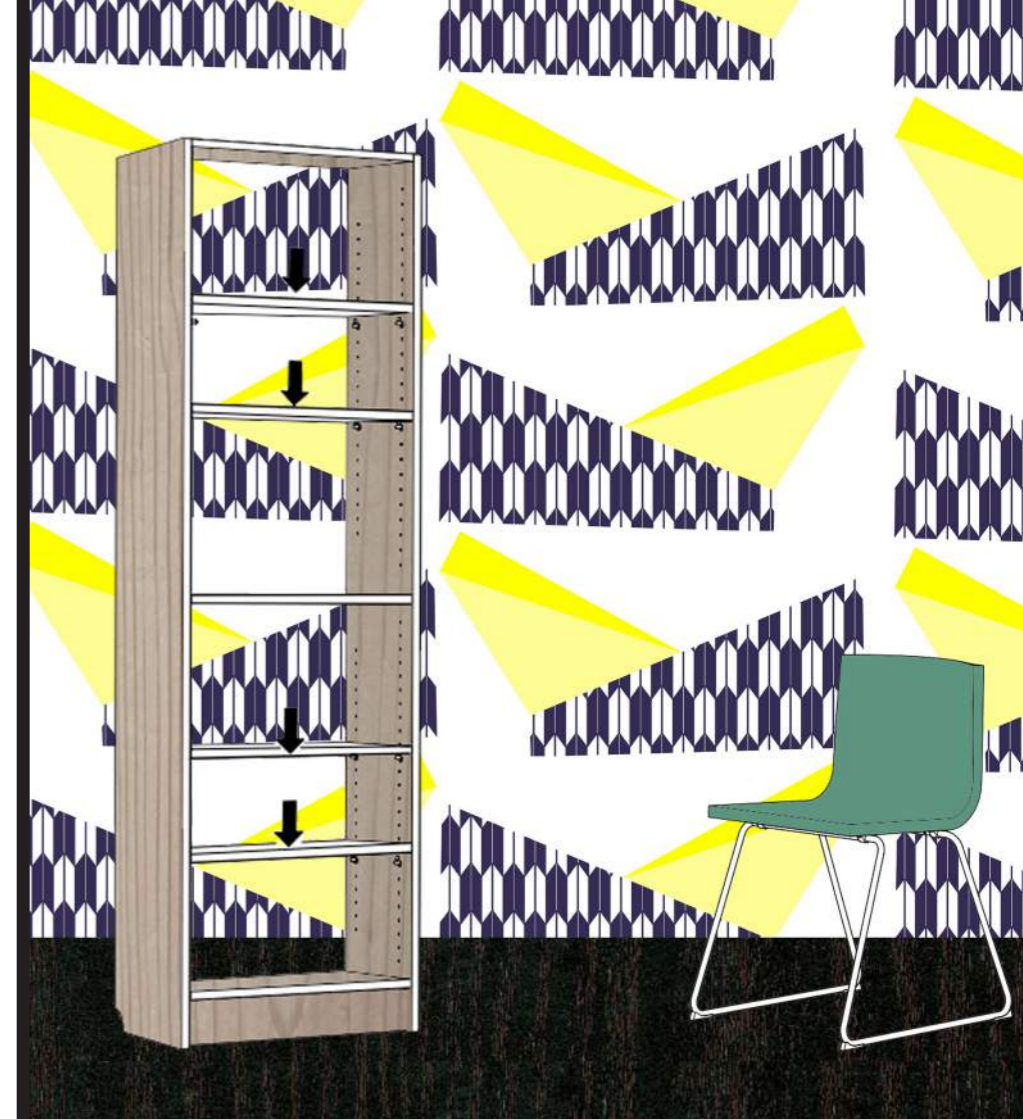



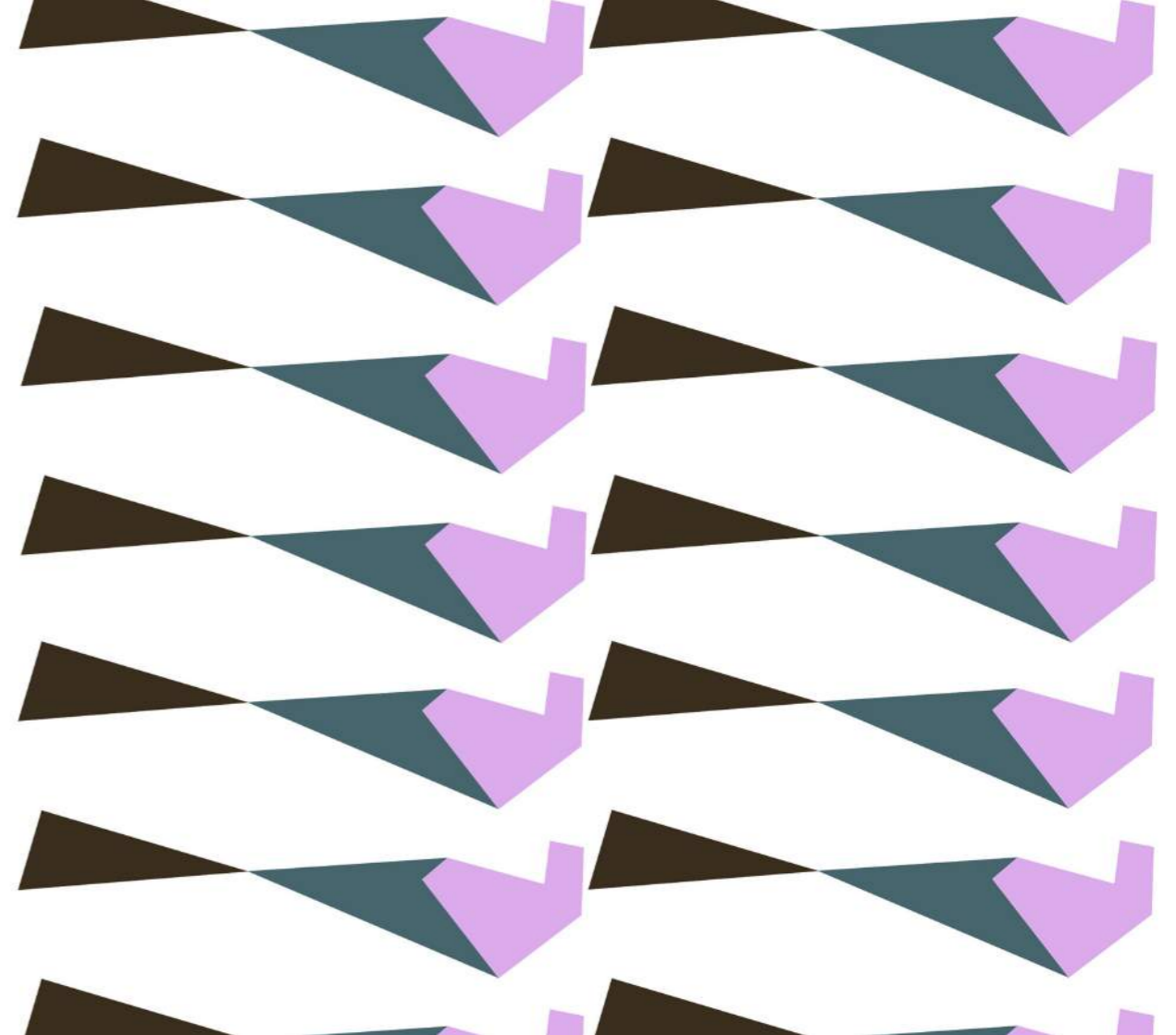
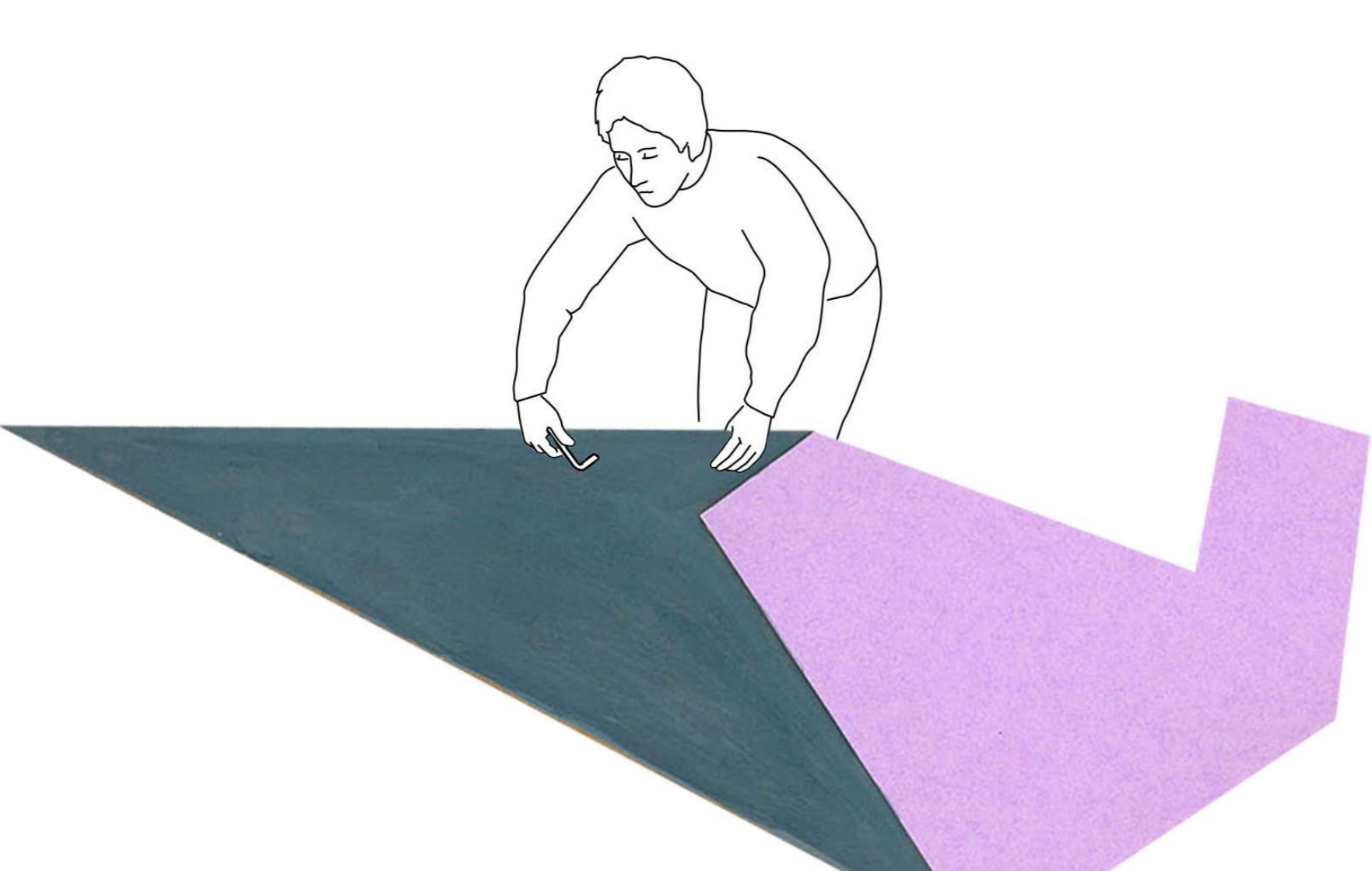

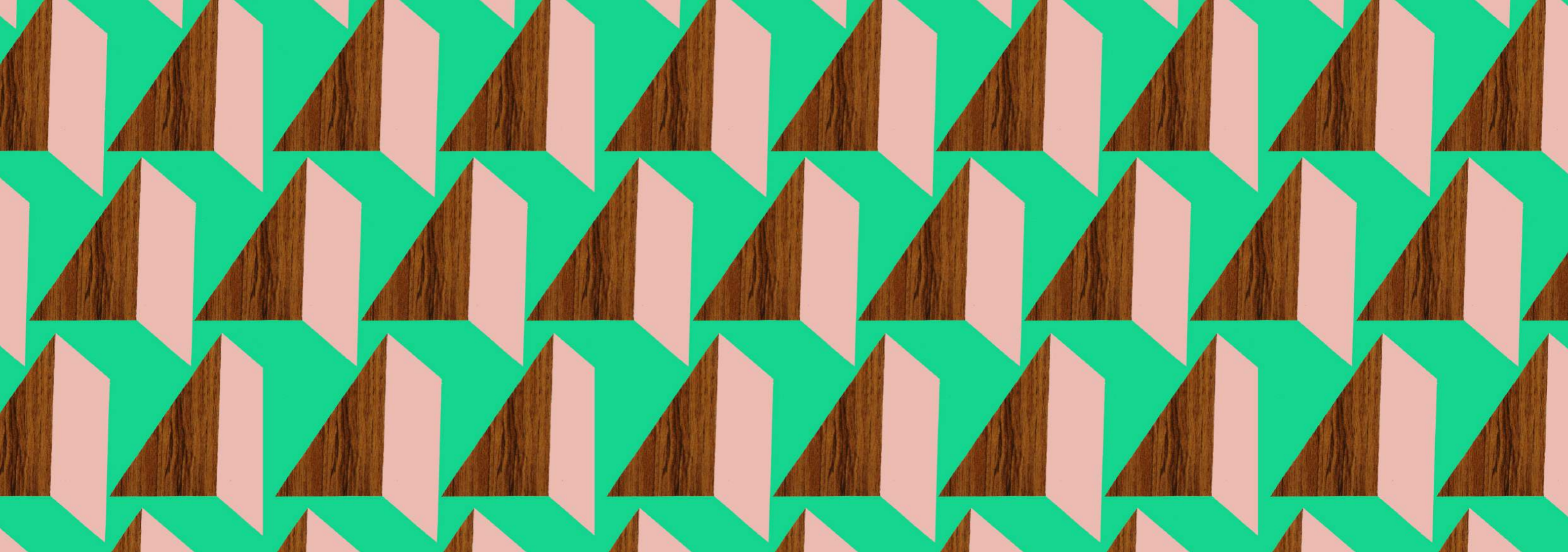

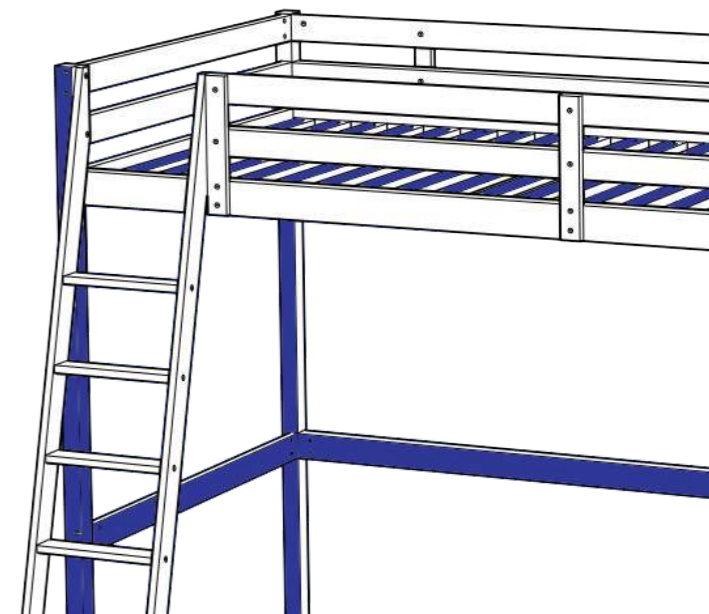
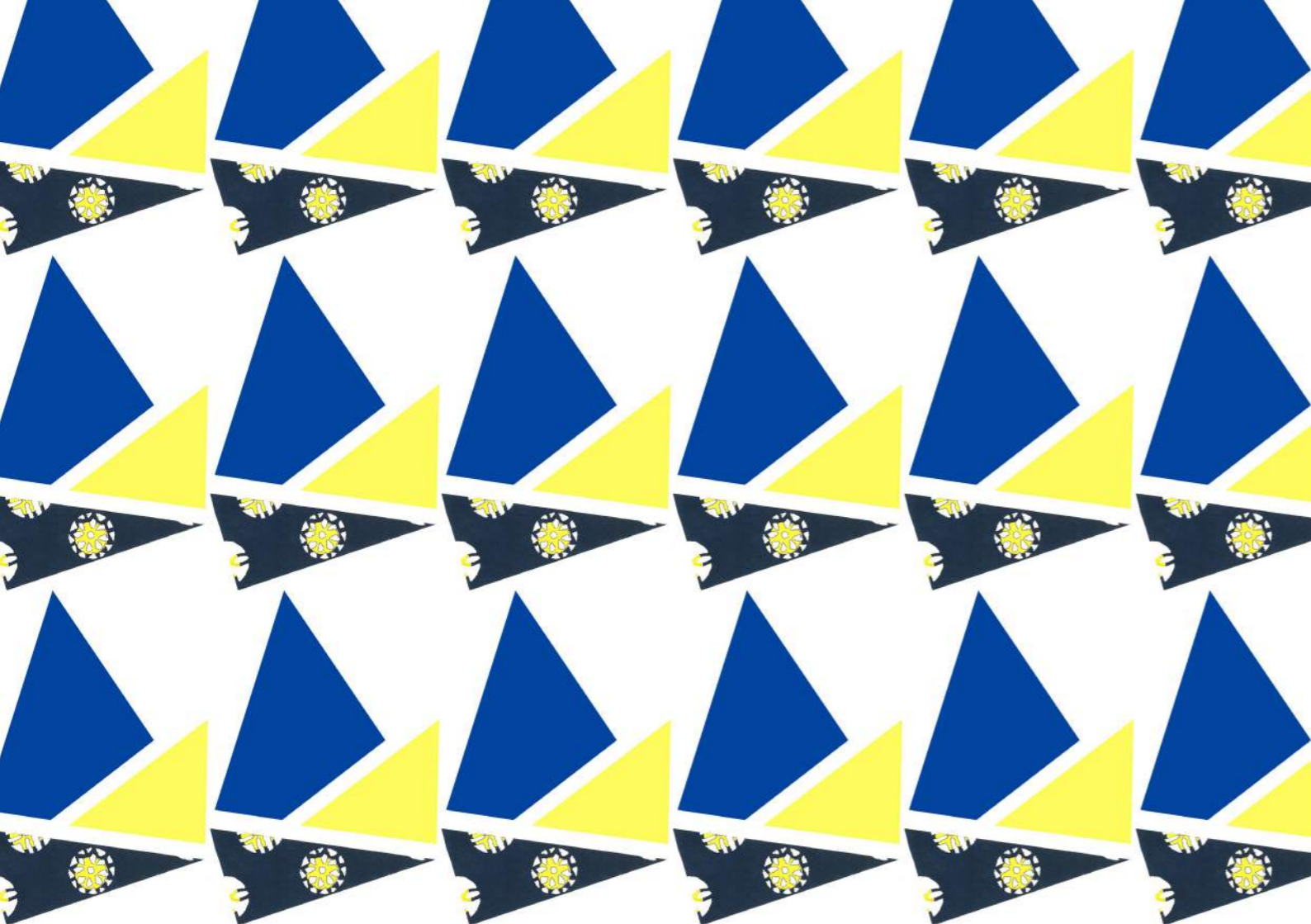

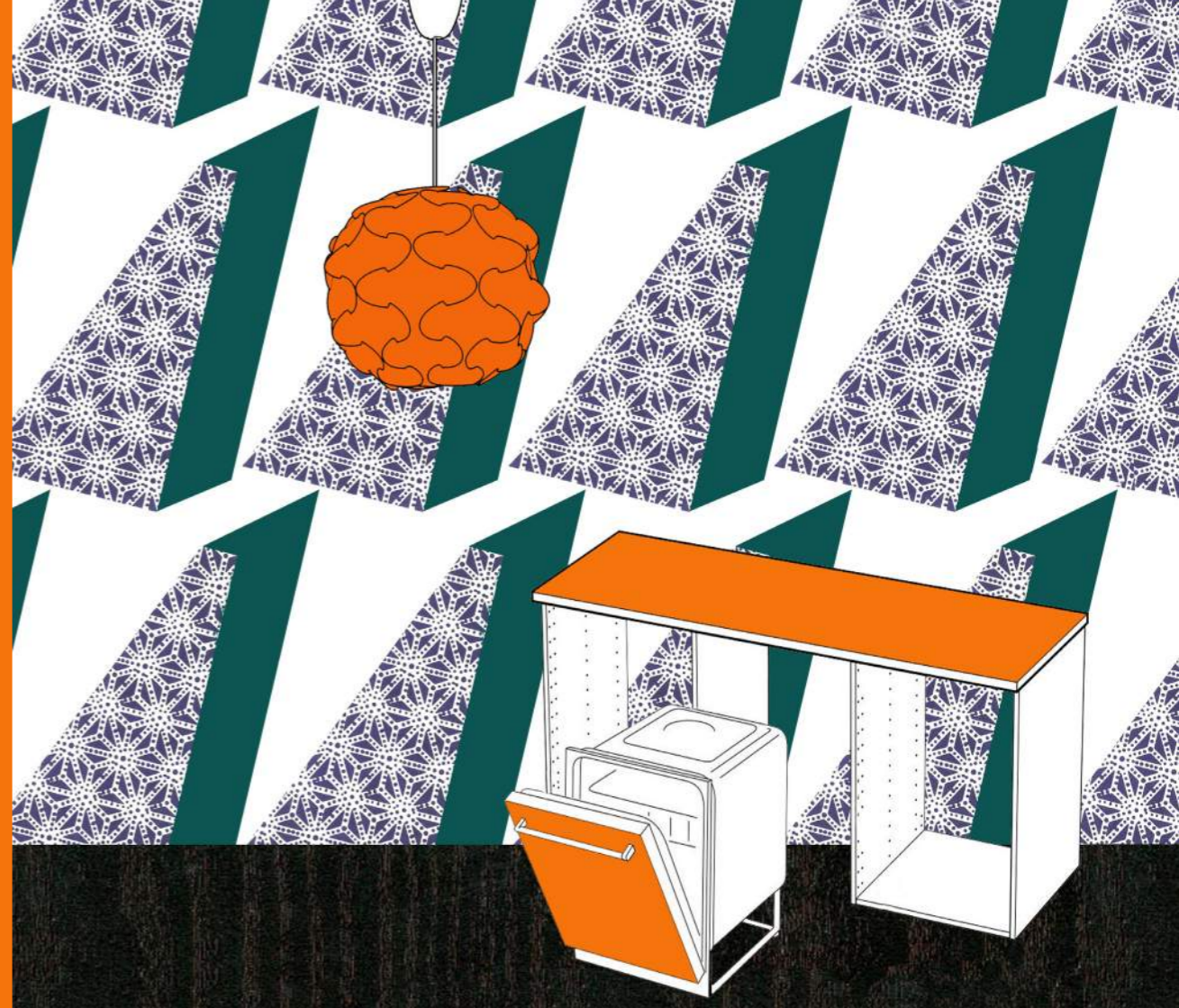
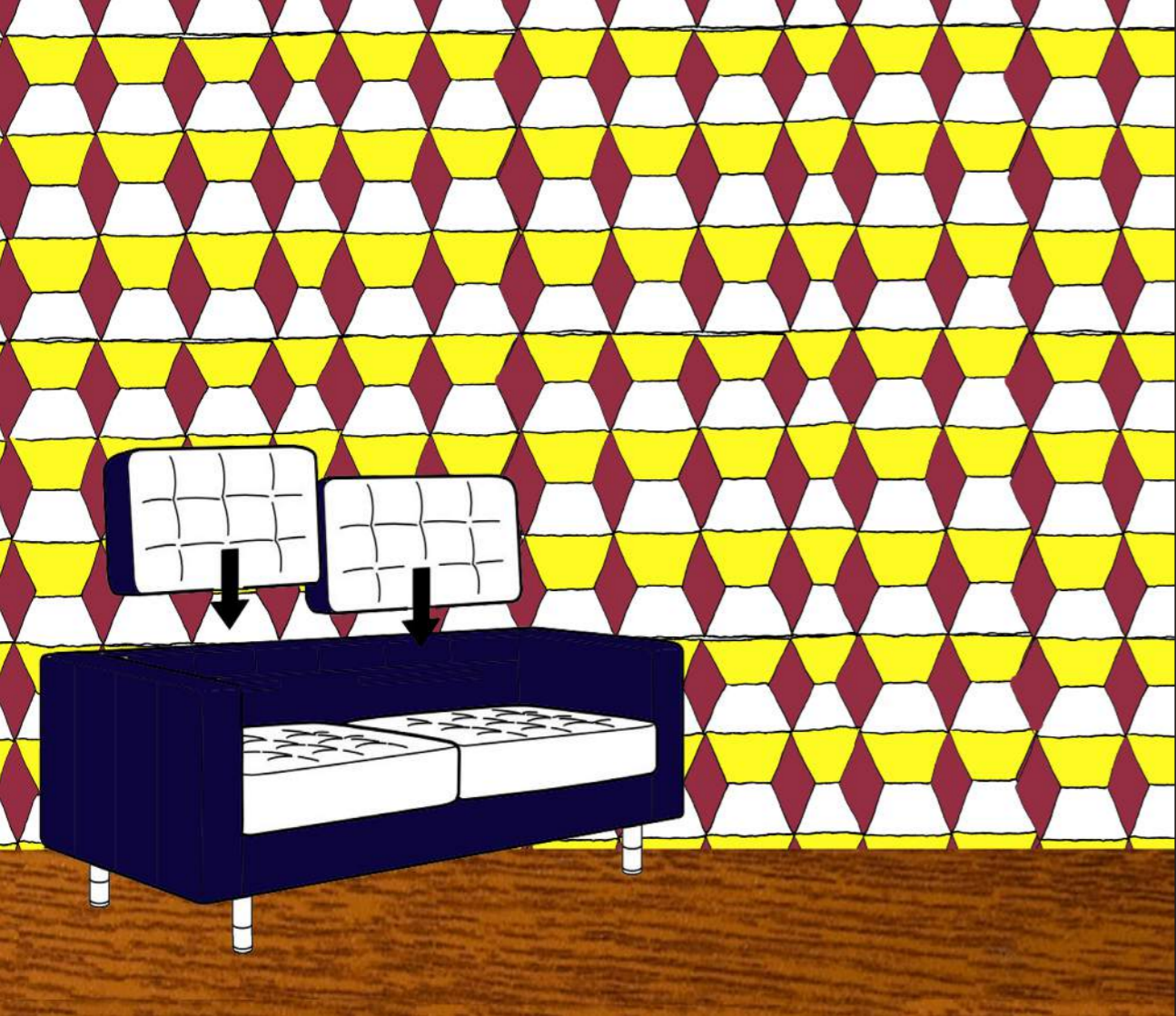

17

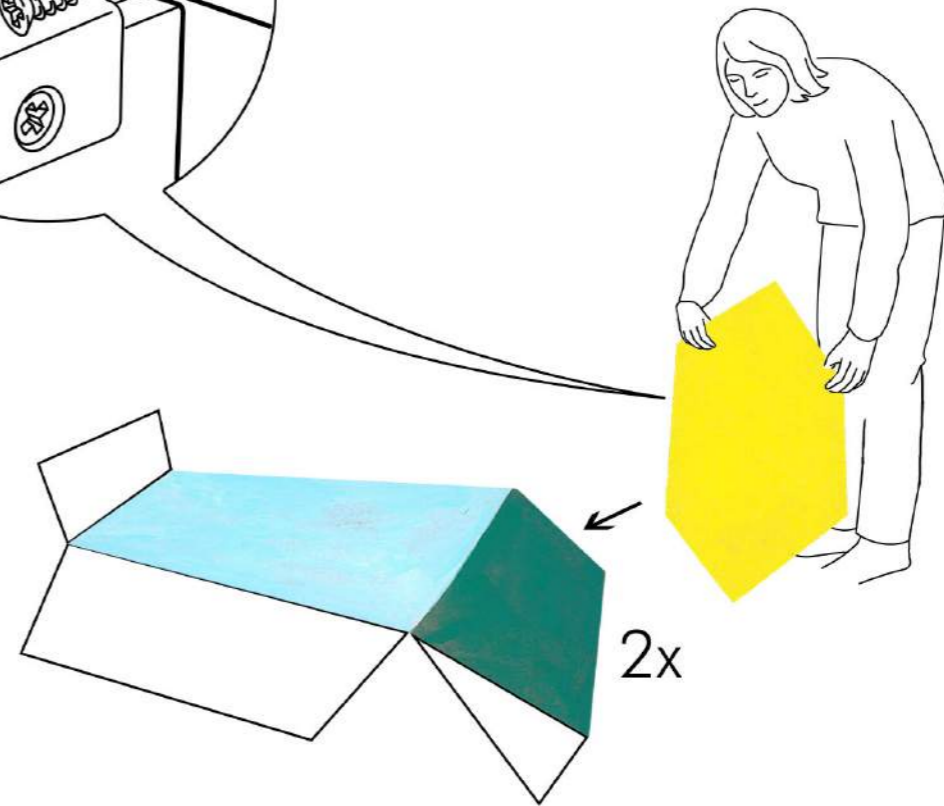
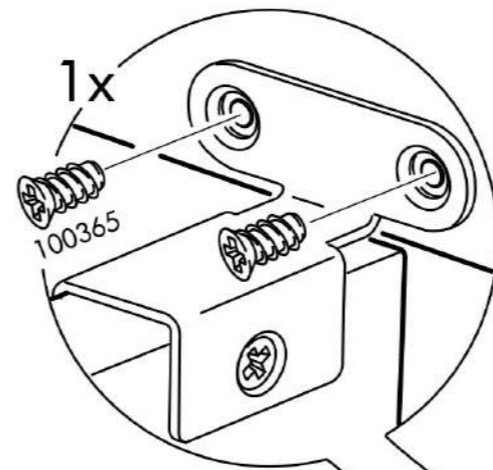

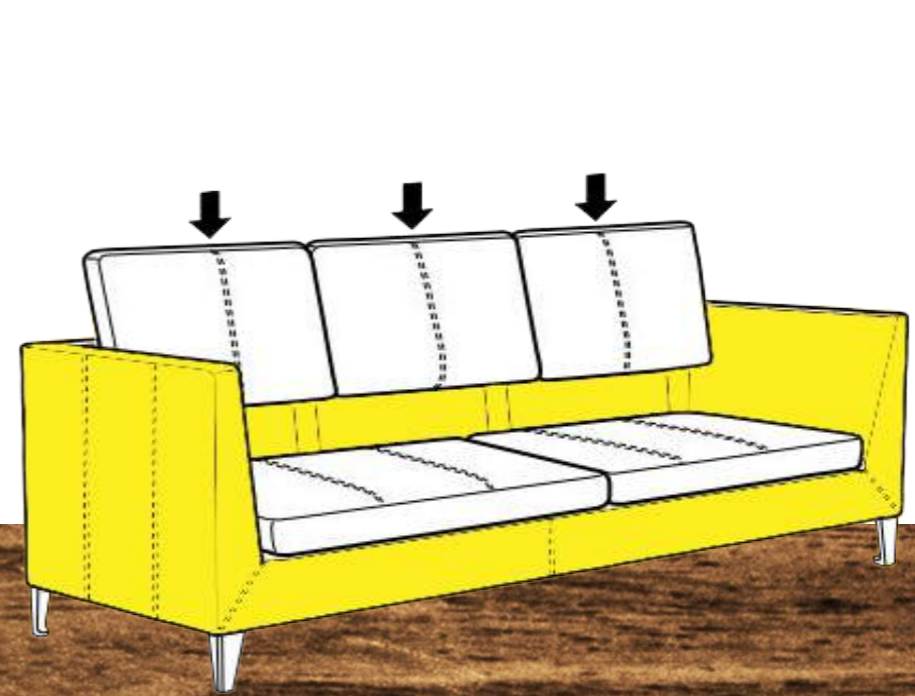

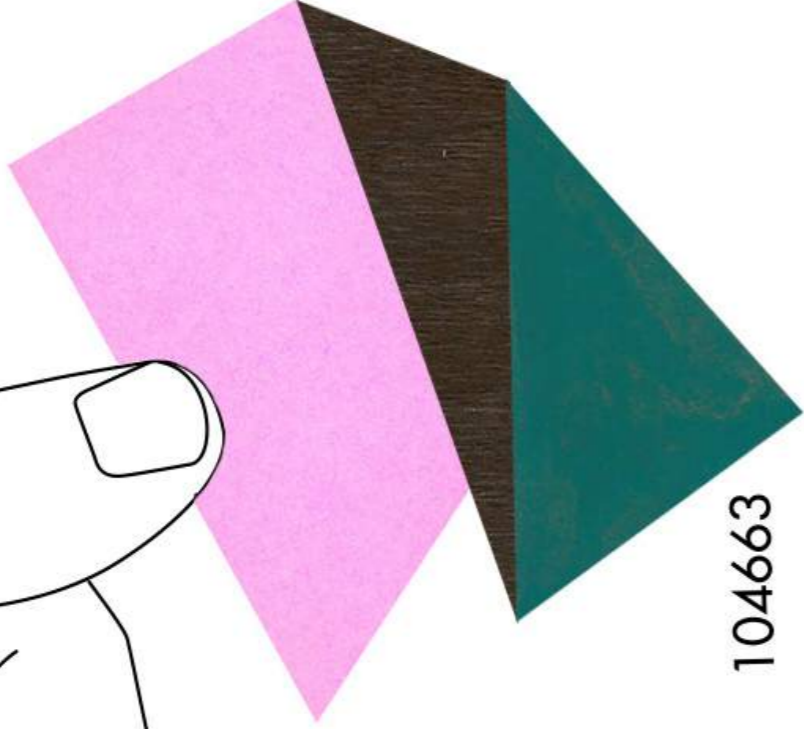

104663



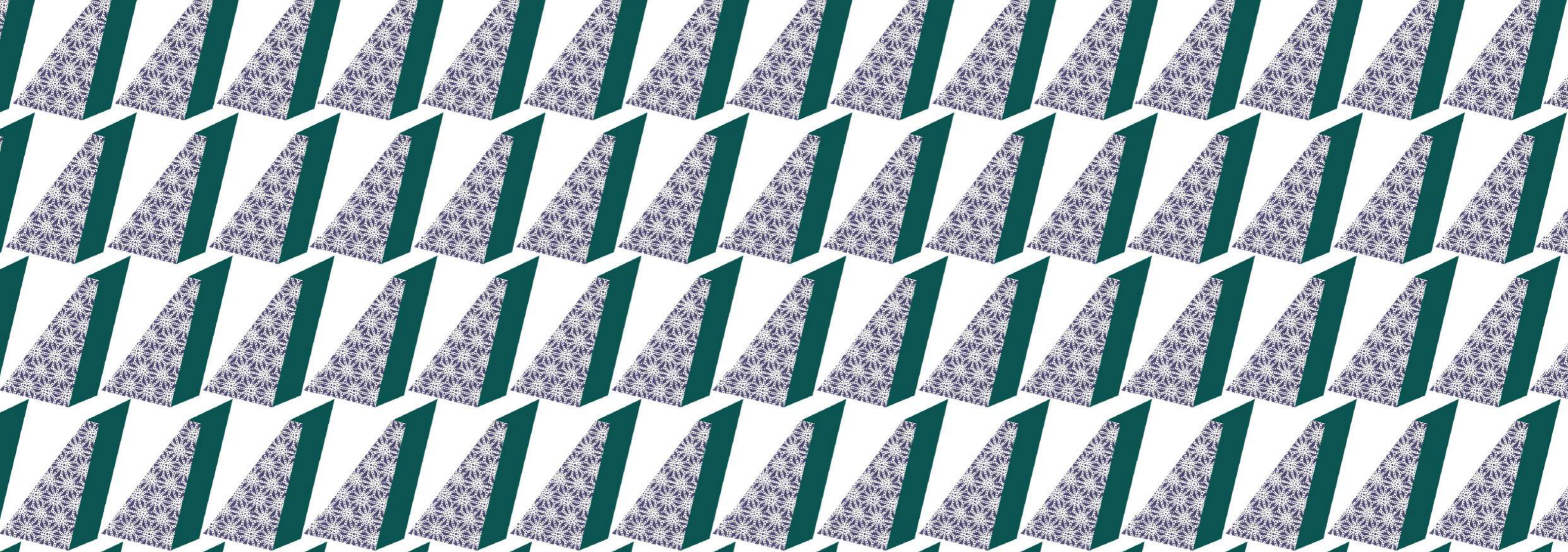

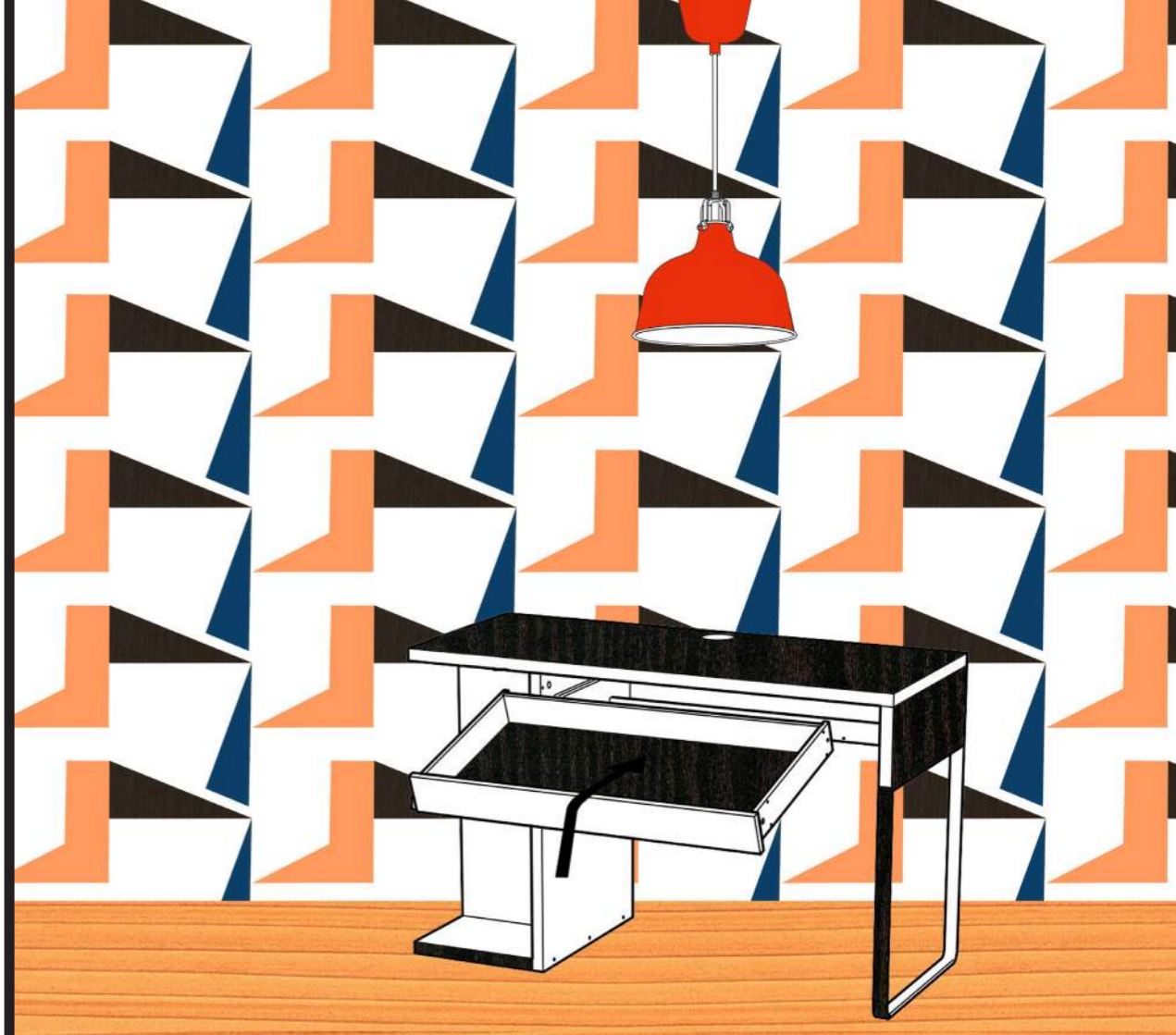
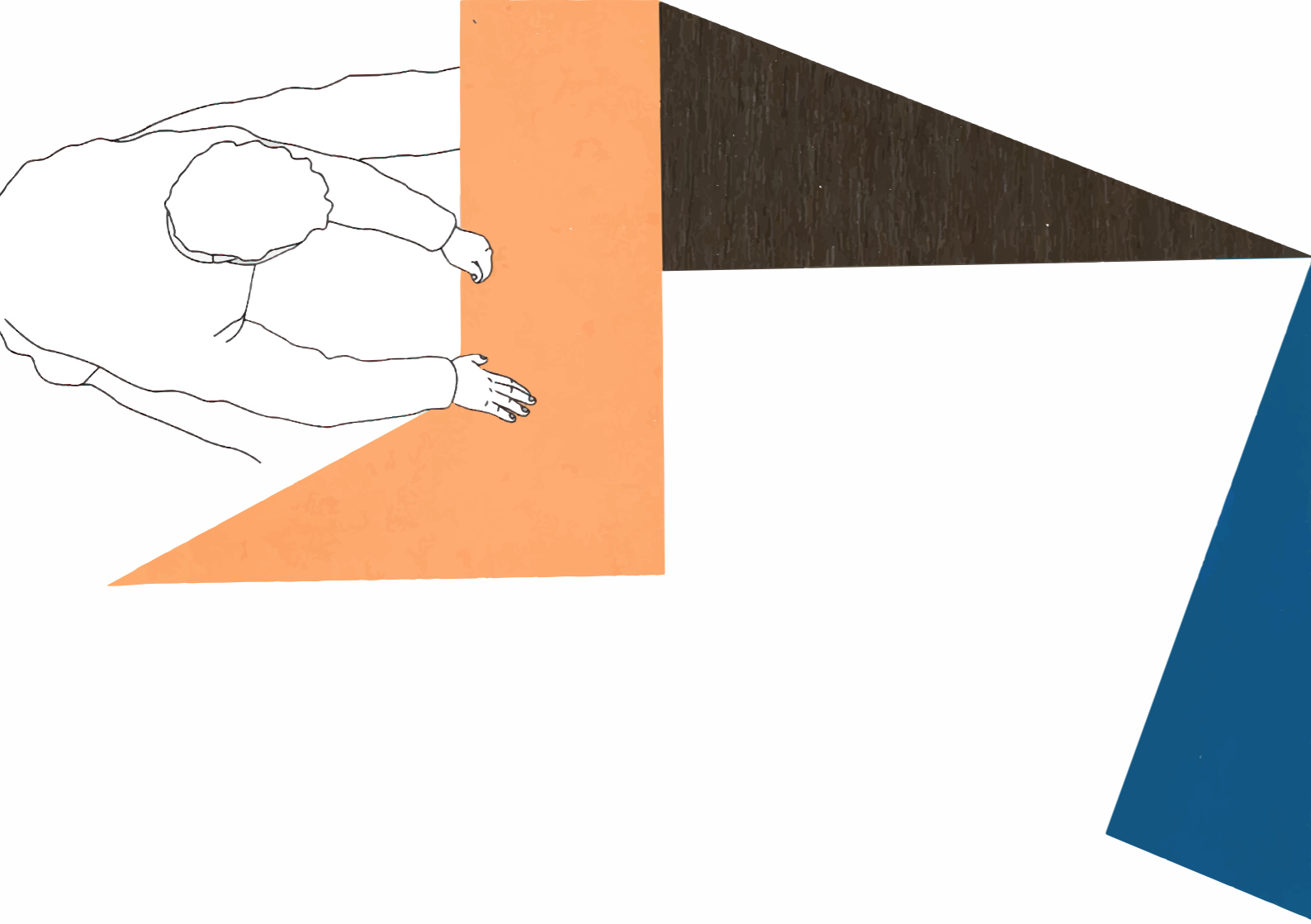

INTÉRIEURS EN KIT
MONA THOMAS

#07 LA COLLECTION

ÉCOLE SUPÉRIEURE D'ART D'AIX-EN-PROVENCE

ACHEVÉ D'IMPRIMER LE 27 MAI 2015
1^{ER} TIRAGE À 100 EXEMPLAIRES

ISBN 979-10-93563-13-8



École supérieure d'Art
Aix-en-Provence



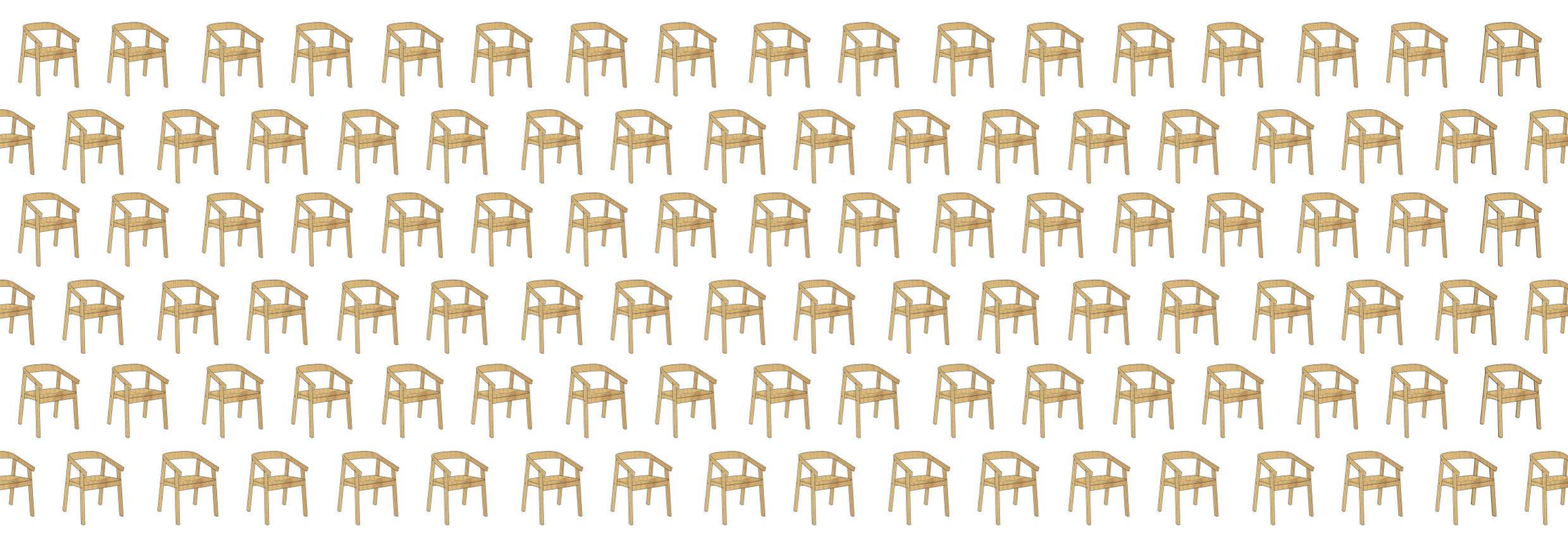

ÉCOLE SUPÉRIEURE D'ART D'AIX-EN-PROVENCE
2015